

# Manitowoc Cranes

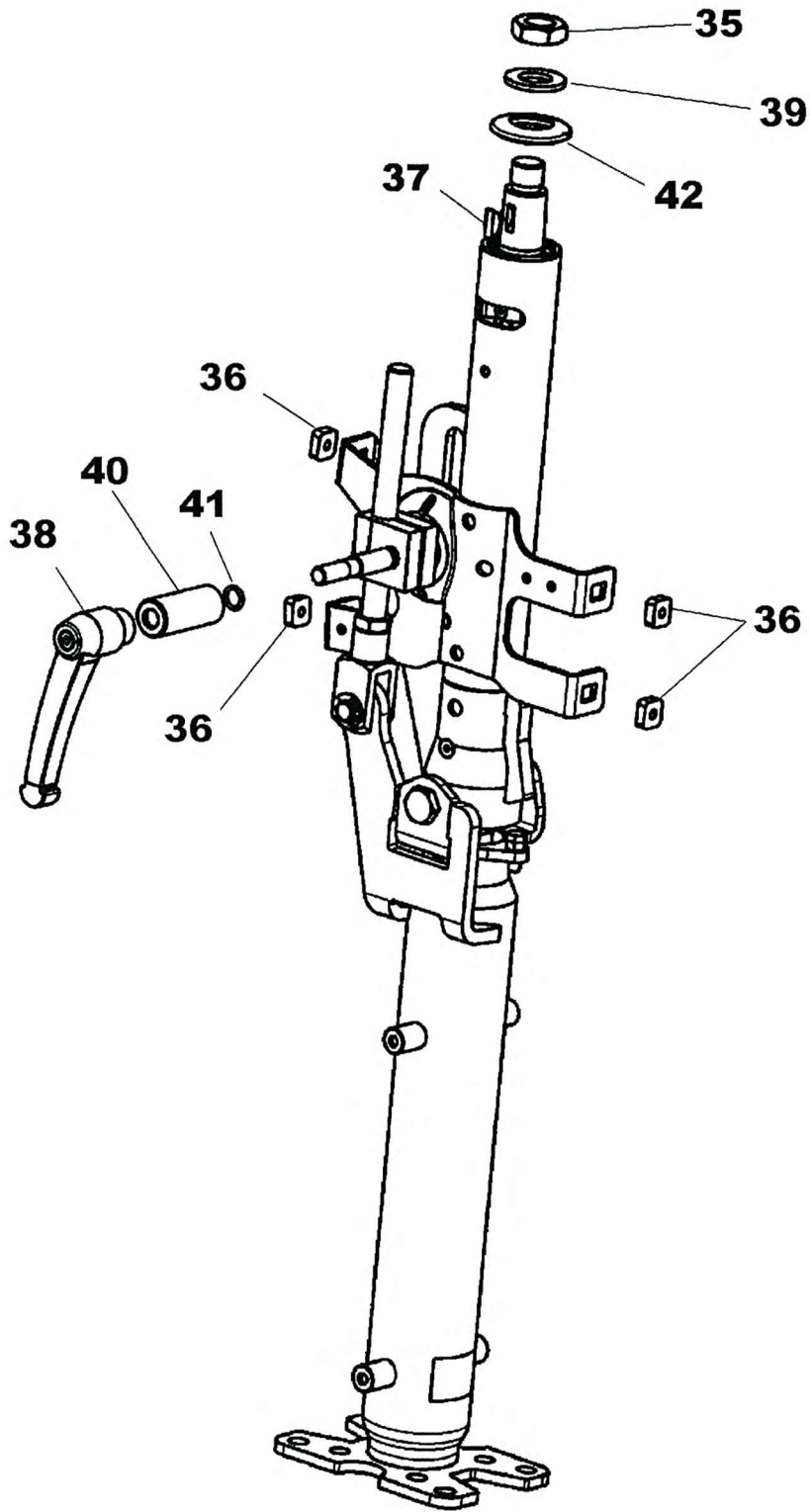

80027679

(SHEET 3 OF 3)

Page 484